



ARIAS COMERCIAL
IMPORTADORES Y DISTRIBUIDORES
Al servicio de la industria y ferretería
arcosacr@yahoo.com



2265-6620
8679-6520

Heredia, San Joaquín.

RUEDAS PARA MOBILIARIO



serie. GLOBUS

serie. DOMUS

serie. FORCELLA-D

**serie. FORCELLA
Gemellata**







serie. FORCELLA-DY

FORCELLA **D**



Ruota monolitica in poliammide 6 nero (ø 30), in polimero termoplastico nero (ø 40, 50, 60 e 80)











One piece black polyamide 6 wheel (ø 30), one piece black thermoplastic polymer wheel (ø 40, 50, 60 and 80)

|  |  |  |  |  |  |
|---|---|---|---|---|---|
| mm | Type | mm | mm | mm | DaN |
| 30 | D | 5 | 21,5 | 15 | 20 |
| 40 | D | 7-8 | 22 | 18 | 25 |
| 50 | D | 7-8 | 22 | 18 | 35 |
| 60 | D | 8-10 | 27 | 21,5 | 40 |
| 80 | D | 8-10 | 27 | 21,5 | 50 |



Supporto girevole in lamiera stampata e zincata con attacco a piastra. Sistema rotante su doppia corona di sfere.

Swivel pressed steel, zinc plated housing, with plate fitting. Double ball race.











|  |  |  |  |  |  |  |  |  |  |  |
|---|---|---|--|--|--|--|--|---|--|--|
| mm | Type | DaN | mm | mm | mmxmm | mm | mmxmm | mmxmm | mmxmm | mm |
| 30 | DP | 20 | 49 | 12,5 | 38x38 | 4,3 | 29,5x29,5 | 24x5,2 | - | - |
| 40 | D1P | 25 | 62,5 | 18,5 | 47x47 | 5,5 | 33x33 | 24x6-7 | - | - |
| 50 | D1P | 35 | 67,5 | 18,5 | 47x47 | 5,5 | 33x33 | 24x6-7 | 77 | 77 |
| 60 | D1P | 40 | 80 | 18,5 | 47x47 | 5,5 | 33x33 | 28x7-8 | 77 | 77 |
| 80 | D1P | 45 | 98 | 18,5 | 47x47 | 5,5 | 33x33 | 28x7-8 | 77 | 77 |



Supporto girevole in lamiera stampata zincata con attacco a foro centrale.

Sistema rotante su doppia corona di sfere.

Swivel pressed steel, zinc plated housing, with bolt hole fitting. Double ball race.

|  |  |  |  |  |  |  |  |  |  |  |
|---|---|---|---|---|---|---|---|--|---|---|
| mm | Type | DaN | mm | mm | mm | mm | mm | mmxmm | mmxmm | mm |
| 40 | DO | 25 | 62,5 | 18,5 | 10 | 34 | 24x6-7 | - | - | - |
| 50 | DO | 35 | 67,5 | 18,5 | 10 | 34 | 24x6-7 | 77 | 77 | 77 |
| 60 | DO | 40 | 80 | 18,5 | 10 | 34 | 28x7-8 | 77 | 77 | 77 |
| 80 | DO | 45 | 98 | 18,5 | 10 | 34 | 28x7-8 | 77 | 77 | 77 |



ARIAS COMERCIAL
 IMPORTADORES Y DISTRIBUIDORES
 Al servicio de la industria y ferretería
arcosacr@yahoo.com



2265-6620
 8679-6520

Heredia, San Joaquín.

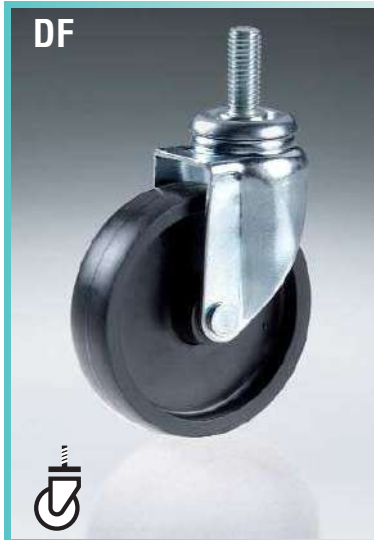

DF

Supporto girevole in lamiera stampata e zincata con attacco a codolo filettato.
Sistema rotante su doppia corona di sfere.

Swivel pressed steel, zinc plated housing, with threaded stem fitting.
Double ball race.

| mm | Type | DaN | mm | mm | mm | mm | mm | mmxmm | mm |
|----|------|-----|----|------|----|-----|----|--------|----|
| 30 | DF | 20 | 49 | 12,5 | 16 | M8 | 29 | 24x5,2 | - |
| 40 | DF | 25 | 62 | 18,5 | 25 | M10 | 34 | 24x6-7 | - |
| 50 | DF | 35 | 67 | 18,5 | 25 | M10 | 34 | 24x6-7 | 77 |
| 60 | DF | 40 | 80 | 18,5 | 25 | M10 | 34 | 28x7-8 | 77 |
| 80 | DF | 45 | 98 | 18,5 | 25 | M10 | 34 | 28x7-8 | 77 |



DF/2



DE

∅ = 13/15/17/19/
21/24/26
■ = 13/15/17/22

Supporto girevole in lamiera stampata e zincata con attacco ad espansione in gomma. Sistema rotante su doppia corona di sfere.

Swivel pressed steel, zinc plated housing, with rubber expander fitting.
Double ball race.

| mm | Type | DaN | mm | mm | mm | mm | mm | mmxmm | mm |
|----|------|-----|------|------|----|----|----|--------|----|
| 30 | DE | 20 | 49 | 12,5 | 16 | * | 29 | 24x5,2 | - |
| 40 | DE | 25 | 62,5 | 18,5 | 25 | * | 34 | 24x6-7 | - |
| 50 | DE | 35 | 67,5 | 18,5 | 25 | * | 34 | 24x6-7 | 77 |
| 60 | DE | 40 | 80 | 18,5 | 25 | * | 34 | 28x7-8 | 77 |
| 80 | DE | 45 | 98 | 18,5 | 25 | * | 34 | 28x7-8 | 77 |



DE/2



DA

∅ = 12/14/16/18/
20/23

Supporto girevole in lamiera stampata e zincata con attacco a bussola alettata in plastica nera.
Sistema rotante su doppia corona di sfere.

Swivel pressed steel, zinc plated housing, with black plastic finned socket fitting.
Double ball race.

| mm | Type | DaN | mm | mm | mm | mm | mm | mmxmm | mm |
|----|------|-----|------|------|----|----|----|--------|----|
| 30 | DA | 20 | 49 | 12,5 | 16 | * | 29 | 24x5,2 | - |
| 40 | DA | 25 | 62,5 | 18,5 | 25 | * | 34 | 24x6-7 | - |
| 50 | DA | 35 | 67,5 | 18,5 | 25 | * | 34 | 24x6-7 | 77 |
| 60 | DA | 40 | 80 | 18,5 | 25 | * | 34 | 28x7-8 | 77 |
| 80 | DA | 45 | 98 | 18,5 | 25 | * | 34 | 28x7-8 | 77 |



DA/2M



ARIAS COMERCIAL
IMPORTADORES Y DISTRIBUIDORES
Al servicio de la industria y ferretería
arcosacr@yahoo.com



2265-6620
8679-6520
Heredia, San Joaquín.

FORCELLA **D**



Supporto girevole in lamiera stampata e zincata con attacco a codolo per bussola alettata (bussola fornita a parte). Sistema rotante su doppia corona di sfere.

Swivel pressed steel, zinc plated housing, with knurled stem fitting (finned socket supplied separately). Double ball race.

| mm | Type | DaN | mm | mm | mm | mm | mm | mmxmm | mm |
|----|------|-----|------|------|------|-----|----|--------|----|
| 50 | DC | 35 | 67,5 | 18,5 | 37,5 | 9,9 | 34 | 24x6-7 | 77 |
| 60 | DC | 40 | 80 | 18,5 | 37,5 | 9,9 | 34 | 28x7-8 | 77 |
| 80 | DC | 45 | 98 | 18,5 | 37,5 | 9,9 | 34 | 28x7-8 | 77 |

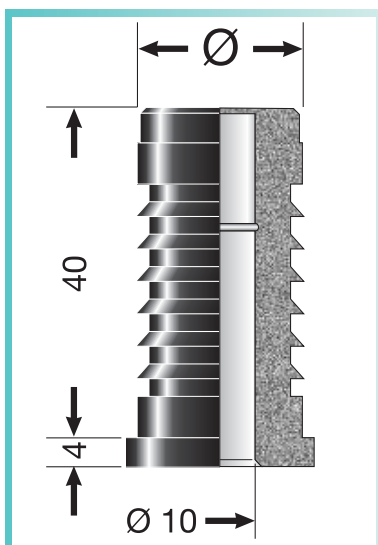

Le bussole alettate vengono fornite separatamente e possono essere di sezione circolare in Polipropilene di colore nero disponibili nei diametri: Ø 19,5 - 22,5 - 25,5, 27 - 27,5. Oppure di sezione quadrata in Nylon di colore bianco disponibili nelle sezioni: □ 18

The finned sockets, supplied separately are as follows :
 - Round, black polypropylene, sockets available in diameters: 19.5 - 22.5 - 25.5 - 27 - 27.5 mm.
 - Square, white Nylon socket, available in 18 mm sq.



Supporto in lamiera stampata zincata con attacco fisso a piastra. Fixed pressed steel, zinc plated housing, with plate fitting.

| mm | Type | DaN | mm | mmxmm | mm | mmxmm | mmxmm |
|----|------|-----|------|---------|-----|-------|--------|
| 40 | DSF | 25 | 62,5 | 48x47,5 | 5,3 | 33x33 | 24x6-7 |
| 50 | DSF | 35 | 67,5 | 48x47,5 | 5,3 | 33x33 | 24x6-7 |
| 60 | DSF | 40 | 80 | 46x48 | 5,3 | 33x33 | 28x7-8 |
| 80 | DSF | 45 | 98 | 46x48 | 5,3 | 33x33 | 28x7-8 |

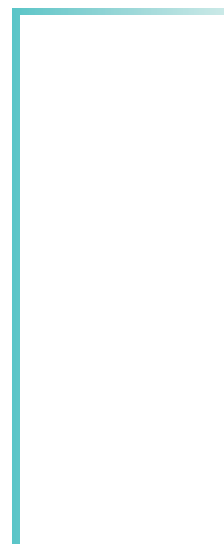

ARIAS COMERCIAL
 IMPORTADORES Y DISTRIBUIDORES
 Al servicio de la industria y ferretería
arcosacr@yahoo.com



2265-6620
 8679-6520

Heredia, San Joaquín.







FORCELLA **D/7**



D/7

Ruota con nucleo in polimero termoplastico negro e rivestimento in gomma termoplastica di colore grigio.

Wheel with black thermoplastic polymer centre and grey synthetic rubber tyre.

|  mm |  Type |  mm |  mm |  mm |  DaN |
|--|--|--|---|--|---|
| 40 | D/7 | 7 | 22 | 14,5 | 25 |
| 50 | D/7 | 7-8 | 22 | 18 | 40 |
| 63 | D/7 | 8-10 | 27 | 22 | 60 |
| 80 | D/7 | 8-10 | 27 | 22 | 60 |
| 100 | D/7 | 8 | 27 | 22 | 60 |



D1P/7

Supporto girevole in lamiera stampata e zincata con attacco a piastra.

Sistema rotante su doppia corona di sfere.

Swivel pressed steel, zinc plated housing, with plate fitting. Double ball race.

|  mm |  Type |  DaN |  mm |  mm |  mmxmm |  mm |  mmxmm |  mmxmm |  mm |
|---|---|--|---|---|--|---|--|--|---|
| 40L | DP/7 | 20 | 54 | 12,5 | 38x38 | 4,3 | 29,5x29,5 | 24x5,2 | - |
| 40 | D1P/7 | 25 | 62,5 | 18,5 | 47x47 | 5,5 | 33x33 | 24x6-7 | - |
| 50 | D1P/7 | 35 | 67,5 | 18,5 | 47x47 | 5,5 | 33x33 | 24x6-7 | 77 |
| 63 | D1P/7 | 40 | 80 | 18,5 | 47x47 | 5,5 | 33x33 | 28x7-8 | 77 |
| 80 | D1P/7 | 50 | 98 | 18,5 | 47x47 | 5,5 | 33x33 | 28x7-8 | 77 |
| 100 | D1P/7 | 50 | 118 | 20 | 47x47 | 5,5 | 33x33 | 28x7-8 | - |



D1P/2/7



DO/7

Supporto girevole in lamiera stampata zincata con attacco a foro centrale.

Sistema rotante su doppia corona di sfere.

Swivel pressed steel, zinc plated housing, with bolt hole fitting. Double ball race.

|  mm |  Type |  DaN |  mm |  mm |  mm |  mm |  mmxmm |  mm |
|--|--|---|--|--|--|--|---|--|
| 40 | DO/7 | 25 | 62,5 | 18,5 | 10 | 34 | 24x6-7 | - |
| 50 | DO/7 | 35 | 67,5 | 18,5 | 10 | 34 | 24x6-7 | 77 |
| 63 | DO/7 | 40 | 80 | 18,5 | 10 | 34 | 28x7-8 | 77 |
| 80 | DO/7 | 50 | 98 | 18,5 | 10 | 34 | 28x7-8 | 77 |
| 100 | DO/7 | 50 | 118 | 20 | 10 | 34 | 28x7-8 | - |



DO/2/7



ARIAS COMERCIAL
 IMPORTADORES Y DISTRIBUIDORES
 Al servicio de la industria y ferretería
arcosacr@yahoo.com



2265-6620
 8679-6520
 Heredia, San Joaquín.

FORCELLA D/7



DF/7



Supporto girevole in lamiera stampata e zincata con attacco a codolo filettato.
Sistema rotante su doppia corona di sfere.

Swivel pressed steel, zinc plated housing, with threaded stem fitting.
Double ball race.

| mm | Type | DaN | mm | mm | mm | mm | mm | mm | mmxmm | mm |
|-----|------|-----|------|------|----|-----|----|--------|-------|----|
| 40L | DF/7 | 20 | 54 | 12,5 | 25 | M10 | 29 | 24x5,2 | - | |
| 40 | DF/7 | 25 | 62,5 | 18,5 | 25 | M10 | 34 | 24x6-7 | - | |
| 50 | DF/7 | 35 | 67,5 | 18,5 | 25 | M10 | 34 | 24x6-7 | 77 | |
| 63 | DF/7 | 40 | 80 | 18,5 | 25 | M10 | 34 | 28x7-8 | 77 | |
| 80 | DF/7 | 50 | 98 | 18,5 | 25 | M10 | 34 | 28x7-8 | 77 | |
| 100 | DF/7 | 50 | 118 | 20 | 25 | M10 | 34 | 28x7-8 | - | |

DF/2/7



DE/7

∅ =
13/15/17/19/
21/24/26
■ =
13/15/17/22



Supporto girevole in lamiera stampata e zincata con attacco ad espansione.
Sistema rotante a doppia corona di sfere.

Swivel pressed steel, zinc plated housing, with rubber expander fitting.
Double ball race.

| mm | Type | DaN | mm | mm | mm | mm | mm | mm | mmxmm | mm |
|----|------|-----|------|------|----|----|----|--------|-------|----|
| 40 | DE/7 | 25 | 62,5 | 18,5 | 25 | * | 34 | 24x6-7 | - | |
| 50 | DE/7 | 35 | 67,5 | 20 | 25 | * | 34 | 24x6-7 | 77 | |
| 63 | DE/7 | 40 | 80 | 20 | 25 | * | 34 | 28x7-8 | 77 | |
| 80 | DE/7 | 50 | 98 | 20 | 25 | * | 34 | 28x7-8 | 77 | |

DE/2/7



DA/7

∅ =
12/14/16/18/
20/23



Supporto girevole in lamiera stampata e zincata con attacco a bussola alettata in plastica nera.
Sistema rotante su doppia corona di sfere.

Swivel pressed steel, zinc plated housing, with black plastic finned socket fitting.
Double ball race.

| mm | Type | DaN | mm | mm | mm | mm | mm | mm | mmxmm | mm |
|----|------|-----|------|------|----|----|----|--------|-------|----|
| 40 | DA/7 | 25 | 62,5 | 18,5 | 25 | * | 34 | 24x6-7 | - | |
| 50 | DA/7 | 35 | 67,5 | 18,5 | 25 | * | 34 | 24x6-7 | 77 | |
| 63 | DA/7 | 40 | 80 | 18,5 | 25 | * | 34 | 28x7-8 | 77 | |
| 80 | DA/7 | 50 | 98 | 18,5 | 25 | * | 34 | 28x7-8 | 77 | |

DA/2/7



ARIAS COMERCIAL
IMPORTADORES Y DISTRIBUIDORES
Al servicio de la industria y ferretería
arcosacr@yahoo.com



2265-6620
8679-6520

Heredia, San Joaquín.

FORCELLA **DY**









DY



Ruote con nucleo in poliammide 6 di colore neutro con rivestimento in poliuretano termoplastico di colore rosso RAL 3020.

Wheels with white Polyamide 6 centre and red (RAL 3020) thermoplastic Polyurethane tyre.



|  mm |  Type |  mm |  mm |  mm |  DaN |
|--|--|--|--|--|---|
| 40 | DY | 7 | 22 | 18 | 50 |
| 50 | DY | 7-8 | 22 | 18 | 55 |
| 63 | TYB | 10 | 27 | 22 | 60 |

DY1P













Supporto girevole in lamiera stampata e zincata con attacco a piastra.

Sistema rotante su doppia corona di sfere.

Swivel pressed steel, zinc plated housing, with plate fitting. Double ball race.

DY1P/2



|  mm |  Type |  DaN |  mm |  mm |  mm |  mm |  mm |  mm |  mm |
|--|--|---|--|--|--|--|--|--|--|
| 40 | DY1P | 35 | 62,5 | 18,5 | 47x47 | 5,5 | 33x33 | 24x6-7 | - |
| 50 | DY1P | 40 | 67,5 | 18,5 | 47x47 | 5,5 | 33x33 | 28x7-8 | 77 |
| 63 | DY1P | 50 | 80 | 18,5 | 47x47 | 5,5 | 33x33 | 28x7-8 | 77 |

DYO











Supporto girevole in lamiera stampata zincata con attacco a foro centrale.

Sistema rotante su doppia corona di sfere.

Swivel pressed steel, zinc plated housing, with bolt hole fitting. Double ball race.

DYO/2



|  mm |  Type |  DaN |  mm |  mm |  mm |  mm |  mm |  mm |
|--|--|---|--|--|--|--|--|--|
| 40 | DYO | 35 | 62,5 | 18,5 | 10 | 34 | 24x6-7 | - |
| 50 | DYO | 40 | 67,5 | 18,5 | 10 | 34 | 28x7-8 | 77 |
| 63 | DYO | 50 | 80 | 18,5 | 10 | 34 | 28x7-8 | 77 |



ARIAS COMERCIAL
 IMPORTADORES Y DISTRIBUIDORES
 Al servicio de la industria y ferretería
arcosacr@yahoo.com



2265-6620
 8679-6520
 Heredia, San Joaquín.

FORCELLA **DY**



DYF



Supporto girevole in lamiera stampata e zincata con attacco a codolo filettato.
Sistema rotante su doppia corona di sfere.

Swivel pressed steel, zinc plated housing, with threaded stem fitting.
Double ball race.

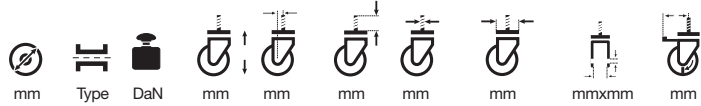

| mm | Type | DaN | mm | mm | mm | mm | mm | mmxmm | mm |
|----|------|-----|------|------|----|-----|----|--------|----|
| 40 | DYF | 35 | 62,5 | 18,5 | 25 | M10 | 34 | 24x6-7 | - |
| 50 | DYF | 40 | 67,5 | 18,5 | 25 | M10 | 34 | 28x7-8 | 77 |
| 63 | DYF | 50 | 80 | 18,5 | 25 | M10 | 34 | 28x7-8 | 77 |

DYF/2



DYSF



Supporto in lamiera stampata zincata con attacco fisso a piastra.
Fixed pressed steel, zinc plated housing, with plate fitting.



| mm | Type | DaN | mm | mmxmm | mm | mmxmm | mmxmm |
|----|------|-----|------|---------|-----|-------|--------|
| 40 | DYSF | 35 | 62,5 | 48x47,5 | 5,3 | 33x33 | 24x6-7 |
| 50 | DYSF | 40 | 67,5 | 48x47,5 | 5,3 | 33x33 | 28x7-8 |
| 63 | DYSF | 50 | 80 | 46x48 | 5,3 | 33x33 | 28x7-8 |



ARIAS COMERCIAL
IMPORTADORES Y DISTRIBUIDORES
Al servicio de la industria y ferretería
arcosacr@yahoo.com



2265-6620
8679-6520
Heredia, San Joaquín.

FORCELLA DR



Ruota monolitica in poliammide 6 di colore nero.
One piece black polyamide 6 wheel.

| mm | Type | mm | mm | mm | DaN |
|----|------|----|------|----|-----|
| 50 | DR | 8 | 26,5 | 22 | 60 |
| 60 | DR | 8 | 26,5 | 22 | 70 |

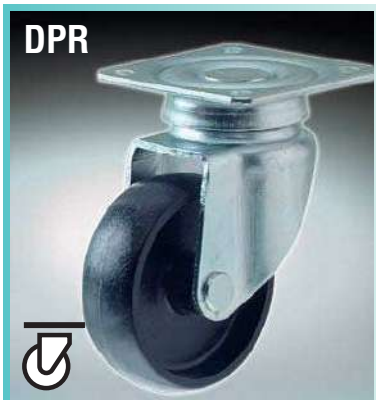

Supporto maggiorato girevole in lamiera stampata e zincata con attacco a piastra.
Sistema rotante su doppia corona di sfere.

Strengthened swivel pressed steel, zinc plated housing, with plate fitting.
Double ball race.

| mm | Type | DaN | mm | mm | mmxmm | mm | mmxmm | mmxmm | mm |
|----|------|-----|----|------|-------|-----|-------|--------|----|
| 50 | DPR | 60 | 70 | 22,5 | 60x60 | 6,3 | 45x45 | 28x7-8 | - |
| 60 | DPR | 70 | 80 | 24,5 | 60x60 | 6,3 | 45x45 | 28x7-8 | 75 |



Supporto maggiorato girevole in lamiera stampata e zincata con attacco a foro centrale.
Sistema rotante su doppia corona di sfere.

Strengthened swivel pressed steel, zinc plated housing, with bolt hole fitting.
Double ball race.

| mm | Type | DaN | mm | mm | mm | mm | mmxmm | mm |
|----|------|-----|----|------|----|----|--------|----|
| 50 | DOR | 60 | 70 | 22 | 12 | 41 | 28x7-8 | - |
| 60 | DOR | 70 | 80 | 24,5 | 12 | 41 | 28x7-8 | 75 |



Supporto maggiorato girevole a codolo filettato in lamiera stampata zincata.
Sistema rotante su doppia corona di sfere.

Strengthened swivel pressed steel, zinc plated housing, with threaded stem fitting.
Double ball race.

| mm | Type | DaN | mm | mm | mm | mm | mm | mmxmm | mm |
|----|------|-----|----|------|----|-----|----|--------|----|
| 50 | DFR | 60 | 70 | 22,5 | 25 | M10 | 41 | 28x7-8 | - |
| 60 | DFR | 70 | 80 | 24,5 | 25 | M10 | 41 | 28x7-8 | 75 |



ARIAS COMERCIAL
IMPORTADORES Y DISTRIBUIDORES
Al servicio de la industria y ferretería
arcosacr@yahoo.com



2265-6620
8679-6520

Heredia, San Joaquín.







FORCELLA

DSFX











Ruota monolitica in polipropilene nero (ø 35) o in poliammide 6 nero (ø 50).

One piece black polypropylene wheel (Ø 35) or black polyamide 6 wheel (Ø 50).

|  mm |  Type |  mm |  mm |  mm |  DaN |
|--|--|--|--|---|---|
| 35 | D-L | 8 | 26,5 | 22 | 25 |
| 50 | DR | 8 | 29,5 | 22 | 60 |

Supporto in lamiera stampata zincata con attacco fisso a piastra con 2 fori.

Fixed pressed steel, zinc plated housing, with plate fitting with 2 holes.

|  mm |  Type |  DaN |  mm |  mmxmm |  mm |  mm |  mmxmm |
|--|--|---|--|---|--|--|---|
| 35 | DSFX | 25 | 36 | 53x32 | 6 | 42 | 28x7-8 |
| 50 | DSFX | 60 | 55 | 53x32 | 6 | 42 | 28x7-8 |



ARIAS COMERCIAL
 IMPORTADORES Y DISTRIBUIDORES
 Al servicio de la industria y ferretería
arcosacr@yahoo.com



2265-6620
 8679-6520
 Heredia, San Joaquín.

FORCELLA

GEMELLATA - TWIN WHEEL



R2

Ruota monolitica in poliammide 6 nero.
One piece black polyamide 6 wheel.

| mm | Type | mm | mm | mm | DaN |
|----|------|----|----|----|-----|
| 50 | R2 | 8 | 22 | 18 | 35 |



R2P

Supporto girevole, per ruota gemellata, in lamiera stampata e zincata con attacco a piastra .
Sistema rotante su doppia corona di sfere.

Swivel pressed steel, zinc plated twin wheel housing, with plate fitting.
Double ball race

| mm | Type | DaN | mm | mm | mmxmm | mm | mmxmm | mmxmm | mm |
|----|------|-----|----|----|-------|-----|-------|----------|----|
| 50 | R2P | 70 | 79 | 26 | 60x60 | 6,6 | 45x45 | 44,4x8,2 | 81 |



R2P/2



R20

Supporto girevole, per ruota gemellata, in lamiera stampata zincata con attacco a foro centrale .
Sistema rotante su doppia corona di sfere.

Swivel pressed steel, zinc plated twin wheel housing, with bolt hole fitting.
Double ball race.

| mm | Type | DaN | mm | mm | mm | mm | mmxmm | mm |
|----|------|-----|----|----|------|----|----------|----|
| 50 | R20 | 70 | 79 | 26 | 12,2 | 48 | 44,4x8,2 | 81 |



R20/2



R2F

Supporto girevole, per ruota gemellata, in lamiera stampata e zincata con attacco a codolo filettato.
Sistema rotante su doppia corona di sfere.

Swivel pressed steel, zinc plated twin wheel housing, with threaded stem fitting.
Double ball race.

| mm | Type | DaN | mm | mm | mm | mm | mm | mmxmm | mm |
|----|------|-----|----|----|----|-----|----|----------|----|
| 50 | R2F | 70 | 79 | 26 | 25 | M10 | 48 | 44,4x8,2 | 81 |



R2F/2



ARIAS COMERCIAL
IMPORTADORES Y DISTRIBUIDORES
Al servicio de la industria y ferretería
arcosacr@yahoo.com



2265-6620
8679-6520

Heredia, San Joaquín.

FORCELLA GEMELLATA - TWIN WHEEL



D/7

Ruota con nucleo in polimero termoplastico nero e rivestimento in gomma termoplastica di colore grigio.

Wheel with black thermoplastic polymer centre and grey synthetic rubber tyre.



mm

50



Type

D/7



mm

8



mm

22



mm

18



DaN

40



R2P/7

Supporto girevole, per ruota gemellata, in lamiera stampata e zincata con attacco a piastra.

Sistema rotante su doppia corona di sfere.

Swivel pressed steel, zinc plated twin wheel housing, with plate fitting.

Double ball race.



mm

50



Type

R2P/7



DaN

70



mm

79



mm

26



mmxmm

60x60



mm

6,6



mmxmm

45x45



mmxmm

44,4x8,2



mm

81



R2P/2/7



R20/7

Supporto girevole, per ruota gemellata, in lamiera stampata zincata con attacco a foro centrale.

Sistema rotante su doppia corona di sfere.

Swivel pressed steel, zinc plated twin wheel housing, with bolt hole fitting.

Double ball race



mm

50



Type

R20/7



DaN

70



mm

79



mm

26



mm

12,2



mm

48



mmxmm

44,4x8,2



mm

81



R20/2/7



R2F/7

Supporto girevole, per ruota gemellata, in lamiera stampata e zincata con attacco a codolo filettato.

Sistema rotante su doppia corona di sfere.

Swivel pressed steel, zinc plated twin wheel housing, with threaded stem fitting.

Double ball race.



mm

50



Type

R2F/7



DaN

70



mm

79



mm

26



mm

25



mm

M10



mm

48



mmxmm

44,4x8,2



mm

81



R2F/2/7



ARIAS COMERCIAL
 IMPORTADORES Y DISTRIBUIDORES
 Al servicio de la industria y ferretería
arcosacr@yahoo.com



2265-6620

8679-6520

Heredia, San Joaquín.



Ruota monolitica in polimero termoplastico.
Laterali in lamiera stampata e ottonata (solo ø 40 e 50).

35 mm dia. - one piece thermoplastic polymer wheel.
40 and 50 mm dia. - one piece thermoplastic polymer wheel with bonded brass plated steel disks.

| mm | Type | mm | mm | mm | DaN |
|----|------|----|----|----|-----|
| 35 | LL | 5 | 15 | 10 | 10 |
| 40 | LL | 5 | 15 | 10 | 12 |
| 50 | LL | 5 | 16 | 12 | 15 |



Supporto girevole in lamiera stampata e ottonata con attacco a piastra . Sistema rotante su una corona di sfere.

Swivel pressed steel, brass plated (standard finish) housing, with plate fitting. Single ball race

| mm | Type | DaN | mm | mm | mmxmm | mm | mmxmm | mm |
|----|------|-----|----|------|-------|-----|-----------|----|
| 35 | P1 | 10 | 53 | 14,5 | 38x38 | 4,3 | 29,5x29,5 | 18 |
| 40 | P1 | 12 | 55 | 14,5 | 38x38 | 4,3 | 29,5x29,5 | 18 |
| 50 | P1 | 15 | 67 | 15 | 38x38 | 4,3 | 29,5x29,5 | 19 |



Supporto girevole in lamiera stampata e ottonata con attacco a codolo filettato . Sistema rotante su una corona di sfere.

Swivel pressed steel, brass plated (standard finish) housing, with threaded stem fitting. Single ball race.

| mm | Type | DaN | mm | mm | mm | mm | mm | mm |
|----|------|-----|----|------|----|----|----|----|
| 35 | F1 | 10 | 53 | 14,5 | M8 | 16 | 29 | 18 |
| 40 | F1 | 12 | 55 | 14,5 | M8 | 16 | 29 | 18 |
| 50 | F1 | 15 | 67 | 15 | M8 | 16 | 29 | 19 |



Supporto girevole in lamiera stampata e ottonata con attacco a codolo zigrinato per legno. Sistema rotante su una corona di sfere.

Swivel pressed steel, brass plated (standard finish) housing, with knurled stem fitting for wood. Single ball race

| mm | Type | DaN | mm | mm | mm | mm | mm | mm |
|----|------|-----|----|------|----|----|----|----|
| 35 | L1 | 10 | 53 | 14,5 | 8 | 26 | 29 | 18 |
| 40 | L1 | 12 | 55 | 14,5 | 8 | 26 | 29 | 18 |
| 50 | L1 | 15 | 67 | 15 | 8 | 28 | 29 | 19 |



ARIAS COMERCIAL
IMPORTADORES Y DISTRIBUIDORES
Al servicio de la industria y ferretería
arcosacr@yahoo.com



2265-6620
8679-6520

Heredia, San Joaquín.

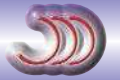

Ruote gemellate con nucleo e supporto girevole in polimero termoplastico con attacco a piastra.

Twin wheel castor with thermoplastic polymer wheels and swivel housing, with plate fitting.



| mm | Type | DaN | mm | mm | mmxmm | mm | mmxmm | mm |
|----|------|-----|----|------|-------|-----|-----------|------|
| 35 | CP | 10 | 52 | 13,5 | 32x32 | 4,4 | 22,5x22,5 | 35,5 |
| 45 | CP | 15 | 60 | 13,5 | 32x32 | 4,4 | 22,5x22,5 | 45 |

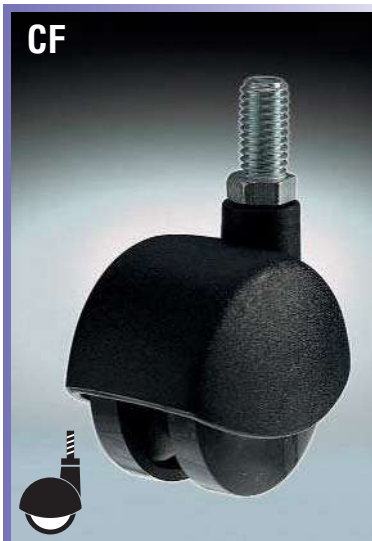

Ruote gemellate con nucleo e supporto girevole in polimero termoplastico con attacco a codolo filettato.

Twin wheel castor with thermoplastic polymer wheels and swivel housing, with threaded stem fitting.

| mm | Type | DaN | mm | mm | mm | mm | mm |
|----|------|-----|------|------|----|----|------|
| 35 | CF | 10 | 47,5 | 13,5 | M8 | 15 | 35,5 |
| 45 | CF | 15 | 55,5 | 13,5 | M8 | 15 | 45 |

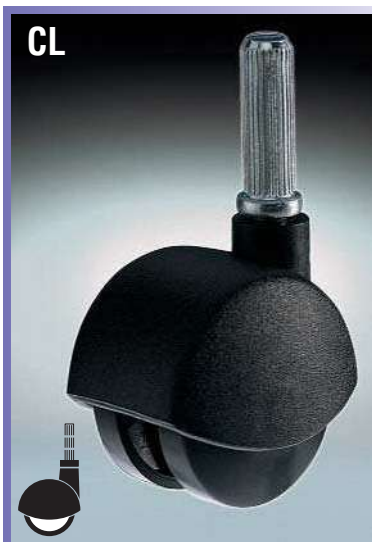

Ruote gemellate con nucleo e supporto girevole in polimero termoplastico con attacco a codolo zigrinato per legno.

Twin wheel castor with thermoplastic polymer wheels and swivel housing, with knurled stem fitting for wood.

| mm | Type | DaN | mm | mm | mm | mm | mm |
|----|------|-----|------|------|----|----|------|
| 35 | CL | 10 | 46,5 | 13,5 | 8 | 26 | 35,5 |
| 45 | CL | 15 | 54,5 | 13,5 | 8 | 26 | 45 |



ARIAS COMERCIAL
 IMPORTADORES Y DISTRIBUIDORES
 Al servicio de la industria y ferretería
arcosacr@yahoo.com



2265-6620
 8679-6520

Heredia, San Joaquín.